

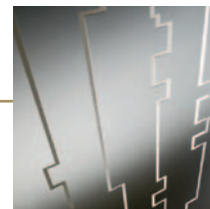

random



Model	H (mm)	D (mm)	L (mm)	 (watt) 	i (mm)
H 1800	1800	90	550	1064	1740
L 1800	550	90	1800	995	1740

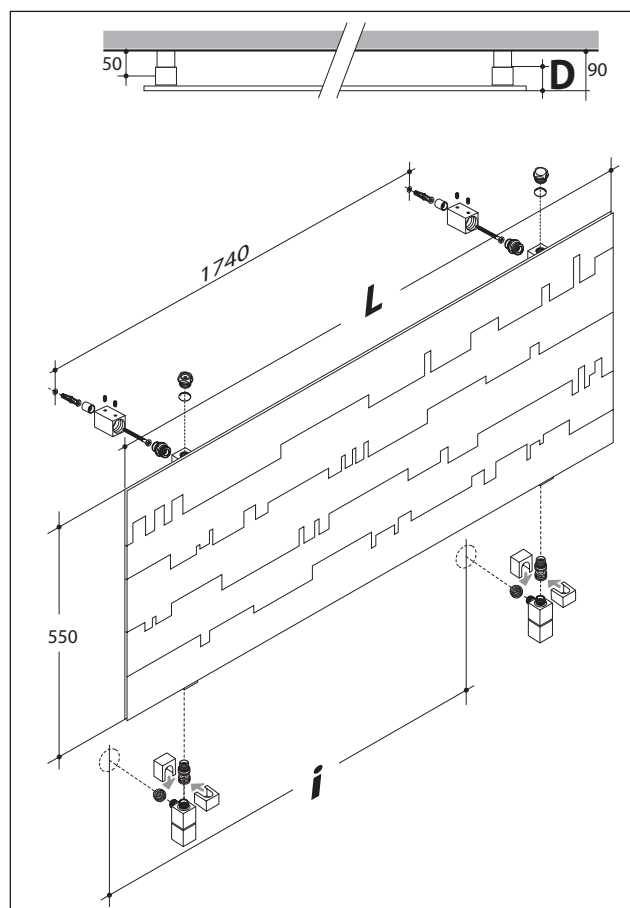
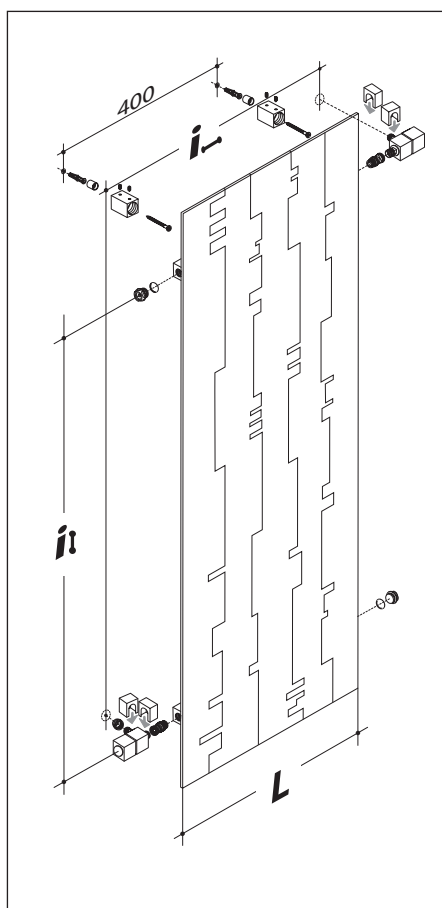

CONNESSIONI/CONNECTIONS

H 1800

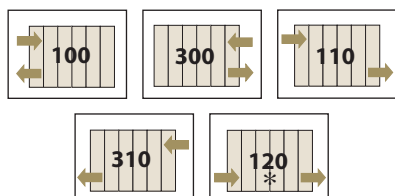

L 1800

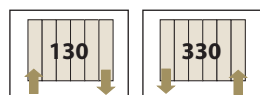

ACCESSORI/ACCESSORIES



*Inserendo il diaframma fornito a kit - *By mounting the diaphragm