

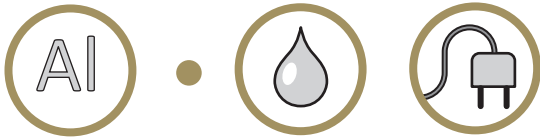



# mirror



Model	H (mm)	D (mm)	L (mm)	 (watt)	 
H 2000	2000	105	1070	1952	

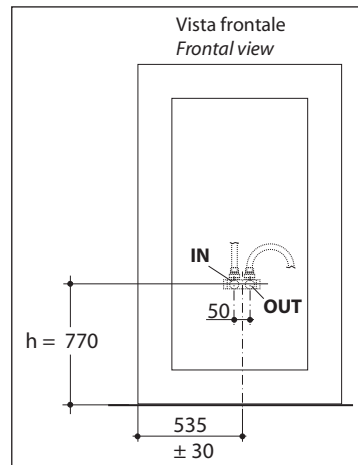
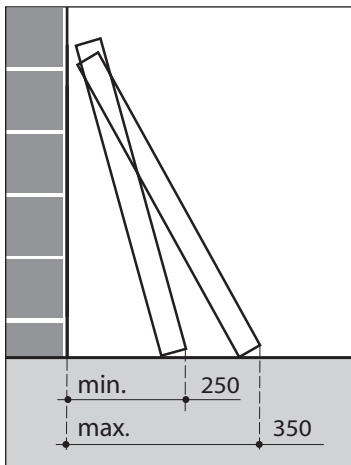

Valvole e flessibili compresi nel prezzo.  
*Valves and flexible connectors are included in the price.*

## ACCESSORI/ACCESSORIES

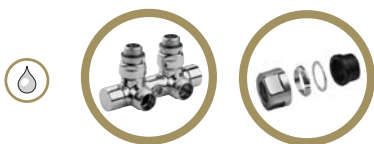

INCLUSA / INCLUDED

